



ZPĚTNÁ AUTOMOBILOVÁ ZRCÁTKA A DRŽÁKY

AUTOMOTIVE REARVIEW MIRRORS AND HOLDERS

KRAFTWAGENAUSSENRÜCKSPIEGEL UND HALTER





Společnost Kovoplast Chlumec nad Cidlinou, a.s. vyrábí a dodává zpětná zrcátka a držáky pro automobilový průmysl (IVECO, SOR, TEDOM, ZETOR ...), televizní, rozhlasové a datové antény, antény pro příjem digitálního vysílání televizního signálu, sejfy, trezory, skříně na zbraně, příruční pokladničky, ruční čerpadla, krbová kamna, sporáky Rekreat a kamna Styl 4 a Styl 6 na tuhá paliva. Společnost získala v roce 1999 certifikát systému řízení jakosti ISO EN 9001 : 2008, který v roce 2011 úspěšně obhájila.



The company Kovoplast Chlumec nad Cidlinou, a.s. is producer and supplier of rearview mirrors and holders for automotive industry (IVECO, SOR, TEDOM, ZETOR ...), TV, radio and data antennas, antennas for receiving of digital broadcasting of TV signal, strongboxes, safes, cash-boxes, manual pumps, fire stoves, solid fuels stoves Rekreat, Styl 4 and Styl 6. The company acquired the Certificate of quality management system ISO EN 9001 : 2008 in year 1999, which defended successfully in 2011.



Gesellschaft Kovoplast Chlumec nad Cidlinou, A.G. ist Hersteller und Lieferant von Rückspiegel und Halter für Autoindustrie (IVECO, SOR, TEDOM, ZETOR ...), Fernseh, Radio- und Datenantennen, Antennen für den Empfang von digitaler Ausstrahlung von TV-Signalen, Safes, Cashboxen, Handpumpen, Feuerherde, für feste Brennstoffe Herde Rekreat, Styl 4 und Styl 6. Das Unternehmen erwarb im Jahr 1999 Qualitätszertifikat ISO EN 9001: 2008, das im Jahr 2011 erfolgreich verteidigt wurde.

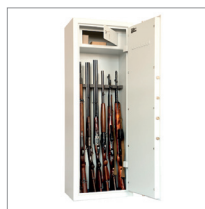

KOVOPLAST Chlumec nad Cidlinou, a.s.

Kozelkova 131/IV, Chlumec nad Cidlinou, 503 51, Czech Republic

Phone: +420 495 484 506, 516, 543, **fax:** +420 495 485 230

E-mail: kovoplast@kovoplast.cz, prodej@kovoplast.cz

www.kovoplast.cz

OBSAH CONTENT

Zrcátko / Mirror Z 200	4
Zrcátko / Mirror Z 201	4
Zrcátko / Mirror Z 320	4
Zrcátka / Mirrors Z 350	5-6
Zrcátko / Mirror Z 358	6
Zrcátka / Mirrors Z 360	7
Zrcátka / Mirrors Z 398	7-8
Zrcátka / Mirrors Z 400	8
Zrcátka / Mirrors Z 430	9
Zrcátko / Mirror Z 600	9
Zrcátka / Mirrors Z 620	10
Zrcátka / Mirrors VKZ 630.....	10,13
Zrcátka / Mirrors Z 700.....	11
Zrcátka / Mirrors Z 750	11-12
Zrcátka / Mirrors Z 800	12
Zrcátko / Mirror Z 860	13
Sady / Sets SOR	14-16
Sady / Sets IVECO	17-18
Sady / Sets TEDOM	18
Sada / Set ŠKODA	19
Sada / Set METRO	19
Držáky / Holders D 1199	20
Držáky / Holders D 210.....	20
Držáky / Holders D 325.....	21
Držáky / Holders D 980.....	21
Držáky / Holders D 1103	21
Držáky / Holders D 220.....	22
Držáky / Holders D 695.....	22
Držáky / Holders D 696.....	22
Držáky / Holders M 1274	22
Držáky / Holders D 705.....	22
Držáky / Holders D 11xx	22
Držáky / Holders D 970.....	23
Držáky / Holders M 10xx.....	23
Držáky / Holders M 12xx.....	23
Držáky / Holders D 1082	23
Držáky / Holders D 1195	24
Držáky / Holders D 12xx	24
Držáky / Holders D 1142	25
Držáky / Holders D 1290	25
Náhradní skla / Spare glasses.....	26-27
Topné vložky / Heating foils	27
Náhradní díly a příslušenství / Spare parts and accessories	28
Vysvětlivky / Legend	29
Katalogová čísla / Catalogue articles	30-31
Certifikát / Certificate ISO EN 9001:2008	32



Z 200

0,3

III.

E 8

PP Ø 9 – 20 mm

Číslo Nr.	Typ / Type	↙ (mm)	Popis / Description
2003	Z 200.100010	145 x 217 x 80	
2502	Z 200	135 x 207	
2480	Z 200	135 x 207	
2701	Z 200		

Z 201

0,3

III.

E 8

PP Ø 9 – 20 mm

Číslo Nr.	Typ / Type	↙ (mm)	Popis / Description
2007	Z 201.100030	145 x 217 x 80	
2501	Z 201	135 x 207	
2481	Z 201	135 x 207	
2706	Z 201		

Z 320 TATRA

0,5

IV.

E 8

ABS Ø 18, 20, 22, 24, 28 mm

Číslo Nr.	Typ / Type	↙ (mm)	Popis / Description
2061	Z 320.10004 UNI	220 x 180 x 165	
2062	Z 320.02404 UNI	220 x 180 x 165	
2489	Z 320	193 x 179	
2490	Z 320	193 x 179	
2530	Z 320	184 x 172	

Z 350



0,45



IV., V.



PP Ø 9 – 20 mm

Číslo Nr.	Typ / Type	↙ (mm)	Popis / Description
2021	Z 350.100040	170 x 258 x 80	
2079	Z 350.100040 Iveco	170 x 258 x 80	
2518	Z 350	161 x 246	
2482	Z 350	161 x 246	
2710	Z 350		

Z 350



0,5



IV., V.



PP Ø 9 – 28 mm

Číslo Nr.	Typ / Type	↙ (mm)	Popis / Description
2022	Z 350.100040 Ø 28	170 x 258 x 100	
2518	Z 350	161 x 246	
2482	Z 350	161 x 246	
2710	Z 350		

Z 350



0,55



IV., V.



PP Ø 9 – 20 mm

Číslo Nr.	Typ / Type	↙ (mm)	Popis / Description
2025	Z 350.012140	170 x 258 x 80	
2026	Z 350.024140	170 x 258 x 80	
2519	Z 350.012,112	161 x 246	
2524	Z 350.024,124	161 x 246	
2520	Z 350.112	158 x 246	
2521	Z 350.124	158 x 246	
2710	Z 350		

Z 350

IV, V.

E 8

PP Ø 20 – 28 mm



0,6



Číslo Nr.	Typ / Type	↙ (mm)	Popis / Description
2023	Z 350.012540 Ø 28	170 x 258 x 100	
2024	Z 350.024540 Ø 28	170 x 258 x 100	
2519	Z 350.012,112	161 x 246	
2524	Z 350.024,124	161 x 246	
2520	Z 350.112	158 x 246	
2521	Z 350.124	158 x 246	
2710	Z 350, Z 398		

Z 350

V.

E 8

PP



0,53



Číslo Nr.	Typ / Type	↙ (mm)	Popis / Description
2032	Z 350.104	258 x 240 x 180	
2518	Z 350	161 x 246	
2482	Z 350	161 x 246	
2710	Z 350		

Z 358

II., III.

N

FEP Ø 16 mm



0,6



Číslo Nr.	Typ / Type	↙ (mm)	Popis / Description
2008	Z 358.100010	177 x 253 x 73	
2504	Z 358	170 x 245	
2483	Z 358	170 x 245	
2702	Z 358, Z 360		

Z 360









0,6



II., III.

N

FEP Ø 16 mm

Číslo Nr.	Typ / Type	↙ (mm)	Popis / Description
2010	Z 360.100030	177 x 253 x 73	   
2506	Z 360	170 x 245	 
2484	Z 360	170 x 245	 
2722	Z 358, Z 360		

Z 360 ARMY





1,4



II., III.

N

FEP Ø 16 mm

Číslo Nr.	Typ / Type	↙ (mm)	Popis / Description
2033	Z 360.10005 ARMY	205 x 285 x 140	   

Z 398 ZETOR

0,55











II., III.

E8

e8

PP Ø 9 – 20 mm

Číslo Nr.	Typ / Type	↙ (mm)	Popis / Description
2031	Z 398.130	170 x 269 x 75	   
2525	Z 398	160 x 260	 
2485	Z 398	160 x 260	 
2710	Z350, Z 398		

Z 398 ZETOR

0,55

II., III.



PP

Ø 9 – 20 mm

Číslo Nr.	Typ / Type	↙ (mm)	Popis / Description
2043	Z 350.104	170 x 269 x 75	
2536	Z 350	160 x 260	
2514	Z 350	158 x 246	
2710	Z 350		

Z 400

0,75



II., III.

N

FEP

Ø 16 mm

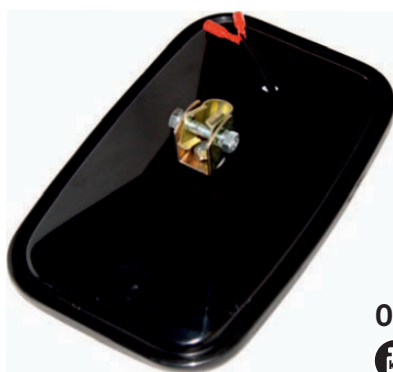
Číslo Nr.	Typ / Type	↙ (mm)	Popis / Description
2011	Z 400.100030	180 x 275 x 80	
2507	Z 400.1	175 x 270	
2486	Z 400	175 x 270	
2703	Z 400		

Z 400

0,8

II., III.

N

FEP

Ø 16 mm

Číslo Nr.	Typ / Type	↙ (mm)	Popis / Description
2012	Z 400.024030	180 x 275 x 80	
2508	Z 400.2	175 x 270	
2514	Z 398, Z 400	158 x 246	
2703	Z 400		

Z 430 AVIA

0,94











II.

E8

PP

Ø 18, 20, 22, 24, 28 mm

Číslo Nr.	Typ / Type	↙ (mm)	Popis / Description
2074	Z 430.100020 UNI	183 x 347 x 85	   
2509	Z 430.1	170 x 335	 
2487	Z 430	170 x 335	 
2704	Z 430, Z 630		

Z 430 AVIA

0,95



























II.

E8

PP

Ø 18, 20, 22, 24, 28 mm

Číslo Nr.	Typ / Type	↙ (mm)	Popis / Description
2075	Z 430.012020 UNI	183 x 347 x 85	    
2076	Z 430.024020 UNI	183 x 347 x 85	    
2510	Z 430.012	170 x 335	   
2511	Z 430.024	170 x 335	   
2515	Z 430.012	160 x 330	  
2517	Z 430.024	160 x 330	  
2704	Z 430, Z 630		

Z 600

2,2















II.

E8

e8

ABS Ø 20 mm

Číslo Nr.	Typ / Type	↙ (mm)	Popis / Description
2316	Z 600.224020	201 x 386 x 119	    
2318	Z 600	181 x 366	   
2317	Z 600	201 x 386 x 70	
2319	Z 600	201 x 386 x 70	
2681	Z 750	Ø 133 x 52	

Z 620 TATRA

1,45

II. ABS Ø 18, 20, 22, 24, 28 mm

Číslo Nr.	Typ / Type	↙ (mm)	Popis / Description
2080	Z 620.400020 N UNI	214 x 370 x 133	
2081	Z 620.424020 N UNI	214 x 370 x 133	
2540	Z 620 NEW	198 x 355 x 30	
2493	Z 620 OLD	198 x 355 x 30	
2531	Z 620	170 x 335	

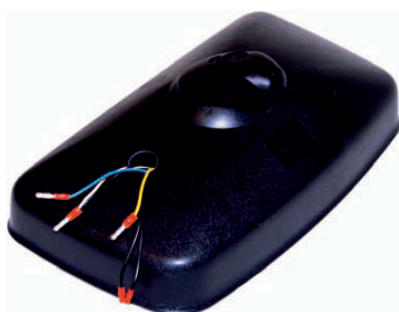
Z 620 TATRA

1,55

II. ABS Ø 18, 20, 22, 24, 28 mm

Číslo Nr.	Typ / Type	↙ (mm)	Popis / Description
2065	Z 620.22402 L N UNI	214 x 370 x 133	
2066	Z 620.22402 P N UNI	214 x 370 x 133	
2540	Z 620 NEW	198 x 355 x 30	
2493	Z 620 OLD	198 x 355 x 30	
2531	Z 620	170 x 335	

VKZ 630

1

N ABS Ø 18 (20, 22, 24, 28) mm

Číslo Nr.	Typ / Type	↙ (mm)	Popis / Description
2091	VKZ 630.100010	Ø 310 x 90	
2090	VKZ 630.100020	Ø 310 x 95	
2537	Z 630.100010	Ø 300	
2538	Z 630.100020	Ø 300	
2704	Z 430, Z 630	Ø 310	

**Z 700 TATRA
LIAZ**



1,15



II. E 8 PP Ø 18, 20, 22, 24, 28 mm

Číslo Nr.	Typ / Type	↙ (mm)	Popis / Description
2072	Z 700.100020 UNI	215 x 410 x 85	
2512	Z 700.1	199 x 397	
2488	Z 700	199 x 397	
2705	Z 700		

**Z 700 TATRA
LIAZ**



1,25



II. E 8 PP Ø 18, 20, 22, 24, 28 mm

Číslo Nr.	Typ / Type	↙ (mm)	Popis / Description
2071	Z 700.024020 UNI	215 x 410 x 85	
2513	Z 700.024	199 x 397	
2516	Z 700	180 x 380	
2705	Z 700		

Z 750 BUS



1,9



II. E 8 e 8 PP Ø 18 – 20 mm

Číslo Nr.	Typ / Type	↙ (mm)	Popis / Description
2030	Z 750.22402 L	213 x 410 x 110	
2029	Z 750.22402 P	213 x 410 x 110	
2661	Z 750	198 x 393 x 29	
2526	Z 750	180 x 380	
2745	Z 750	142 x 150 x 30	
2681	Z 750	Ø 133 x 52	
2746	Z 750	213 x 410 x 80	

Z 750 BUS

1,8

II.

E 8
e8

PP

Ø 18 – 20 mm

Číslo Nr.	Typ / Type	↙ (mm)	Popis / Description
2083	Z 750.424020	213 x 410 x 110	
2082	Z 750.400020	213 x 410 x 110	
2661	Z 750	198 x 393 x 29	
2533	Z 750	191 x 386	
2526	Z 750	180 x 380	
2745	Z 750	142 x 150 x 30	
2746	Z 750	213 x 410 x 80	
2328	Z 750	133 x 52	

Z 800 TATRA

1,8

II.

E 8

ABS

Ø 18, 20, 22, 24, 28 mm

Číslo Nr.	Typ / Type	↙ (mm)	Popis / Description
2069	Z 800.22402 L N UNI	226 x 453 x 130	
2070	Z 800.22402 P N UNI	226 x 453 x 130	
2539	Z 800 NEW	208 x 442 x 30	
2496	Z 800 OLD	208 x 442 x 30	
2532	Z 800	180 x 380	

Z 800 TATRA

1,7

II.

E 8

ABS

Ø 18, 20, 22, 24, 28 mm

Číslo Nr.	Typ / Type	↙ (mm)	Popis / Description
2084	Z 800.400020 N UNI	226 x 453 x 130	
2085	Z 800.424020 N UNI	226 x 453 x 130	
2539	Z 800 NEW	208 x 442 x 30	
2496	Z 800 OLD	208 x 442 x 30	
2532	Z 800	180 x 380	

Z 860 BUS

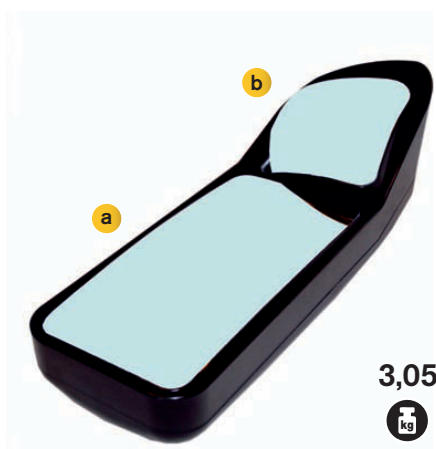

II. E 8 e8 ABS Ø 20 mm

Číslo Nr.	Typ / Type	↙ (mm)	Popis / Description
2330	Z 860.22472 P a b	200 x 529 x 238	
2318	Z 600 a	181 x 366	
2327	Z 260 b	181 x 155	
2325	Z 860	200 x 529 x 195	
2329	Z 860	200 x 529 x 125	
2681	Z 750	Ø 133 x 52	
2328	Z 260	Ø 110 x 40	

VKZ 630 + D 1203

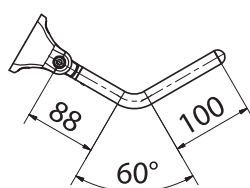

1,2

II. N ABS Ø 18 mm

Číslo Nr.	Typ / Type	↙ (mm)	Popis / Description
2096	VKZ 630.100010 / D 1203.100		
2095	VKZ 630.100020 / D 1203.100		
2091	VKZ 630.100010	Ø 310 x 90	
2090	VKZ 630.100020	Ø 310 x 95	
2580	D 1203.100	Ø 18	
2537	Z 630.100010	Ø 300	
2538	Z 630.100020	Ø 300	
2704	Z430, Z 630	Ø 310	

SOR^C LH IVECO

II.

E 8
e8

ABS Ø 20 mm

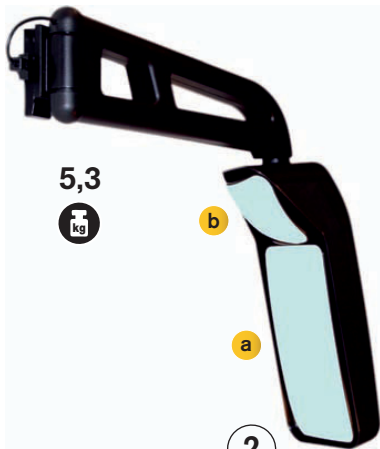

1

3,7

5,3

2

1

Číslo Nr.	Typ / Type	↙ (mm)	Popis / Description
2320	Z 600.224020 / D 1286.20 L	253 x 570 x 206	
2322	D 1286.20 L	128 x 199 x 446	
2316	Z 600.224020	201 x 386 x 119	
2318	Z 600	181 x 366	
2149	Mezikus / Spacer	128 x 48 x 23	
2659	Kabel / Cable	2500	

2

2321	Z 860.22472 P / D 1288.20 P	720 x 270 x 690	
2323	D 1288.20 P	674 x 203 x 560	
2330	Z 860.22472 P a b	200 x 529 x 238	
2318	Z 600 a	181 x 366	
2327	Z 260 b	181 x 155	
2150	Mezikus / Spacer	128 x 48 x 23	
2660	Kabel / Cable	4500	

SOR BNG CNG

II.

E 8
e8

PESL

8,1

4,9

1

Číslo Nr.	Typ / Type	↙ (mm)	Popis / Description
2101	Z 755.22402 L / D 1171.20 L	330 x 640 x 340	
-	D 1171.20 L	233 x 194 x 320	
-	Z 755.22402 L	225 x 500 x 140	
2661	Z 750	198 x 393 x 29	

2

2100	Z 755.22402 P / D 1170.20 P	300 x 620 x 910	
-	D 1170.20 P	110 x 190 x 830	
-	Z 755.22402 P	225 x 500 x 140	
2661	Z 750	198 x 393 x 29	

SOR BN
CN

II. E 8 e8 PP Ø 20 mm

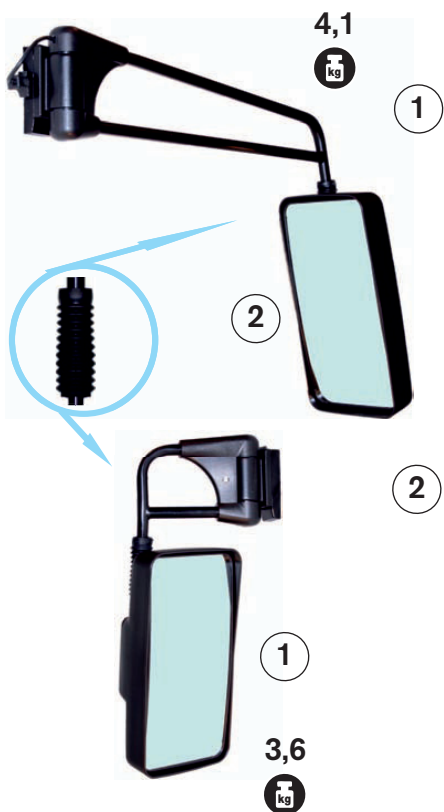

Číslo Nr.	Typ / Type	↙ (mm)	Popis / Description
2217	Z 750.22402 P / D1238.20 L	201 x 255 x 296	
2589	D 1238.20 L	419 x 224 x 130	
2029	Z 750.22402 P	213 x 410 x 110	
2661	Z 750	198 x 393 x 29	
2149	Mezikus / Spacer	128 x 48 x 23	
2659	Kabel / Cable	2500	
2218	Z 750.22402 P / D1239.20 P	765 x 312 x 585	
2590	D 1239.20 P	753 x 161 x 416	
2029	Z 750.22402 P	213 x 410 x 110	
2661	Z 750	198 x 393 x 29	
2150	Mezikus / Spacer	128 x 48 x 23	
2660	Kabel / Cable	4500	

Možné barevné varianty / Possible color variants

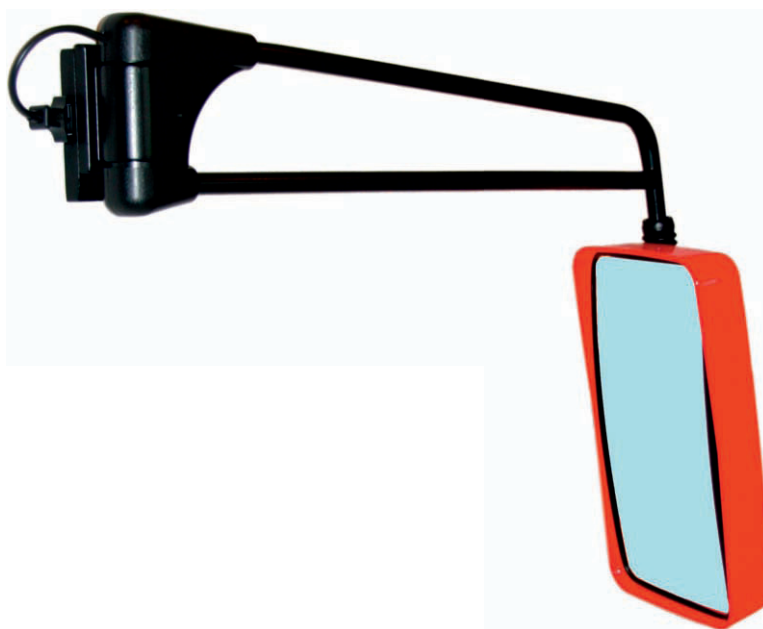

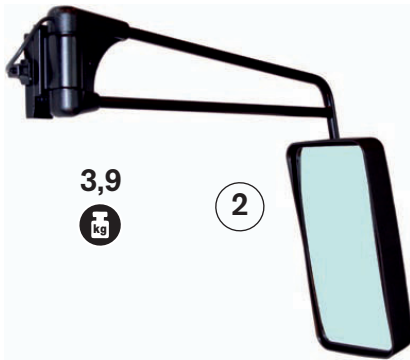
**SOR^C
CG**

3,9

2

1
3,3

II.

E 8
e8

PP

Ø 20 mm

1

Číslo Nr.	Typ / Type	↙ (mm)	Popis / Description
2241	Z 750.22402 P / D 1275.20 L	202 x 258 x 590	
2567	D 1275.20 L	130 x 231 x 421	
2029	Z 750.22402 P	213 x 410 x 110	
2661	Z 750	198 x 393 x 29	
2149	Mezikus / Spacer	128 x 48 x 23	
2659	Kabel / Cable	2500	

2

2240	Z 750.22402 P / D 1271.20 P	769 x 298 x 599	
2576	D 1271.20 P	755 x 178 x 428	
2029	Z 750.22402 P	213 x 410 x 110	
2661	Z 750	198 x 393 x 29	
2150	Z 750	128 x 48 x 23	
2660	Mezikus / Spacer	4500	

**SOR^{NB}
TNB
NBH**

2
3,7

1
3,4

II.

E 8
e8

PP

Ø 20 mm

1

Číslo Nr.	Typ / Type	↙ (mm)	Popis / Description
2231	Z 750.22402 P / D1272.20 L	201 x 255 x 296	
2562	D 1272.20 L	419 x 224 x 130	
2029	Z 750.22402 P	213 x 410 x 110	
2661	Z 750	198 x 393 x 29	
2149	Mezikus / Spacer	128 x 48 x 23	
2659	Kabel / Cable	2500	

2

2230	Z 750.22402 L / D1272.20 P	765 x 312 x 585	
2563	D 1272.20 P	753 x 161 x 416	
2030	Z 750.22402 L	213 x 410 x 110	
2661	Z 750	198 x 393 x 29	
2150	Mezikus / Spacer	128 x 48 x 23	
2660	Kabel / Cable	4500	

IVECO ARWAY CROSSWAY LOW ENTRY

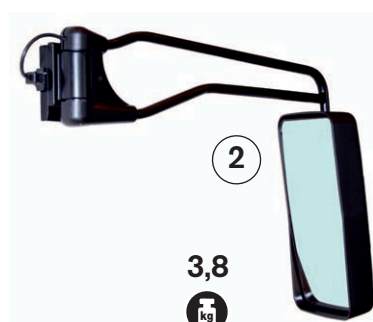
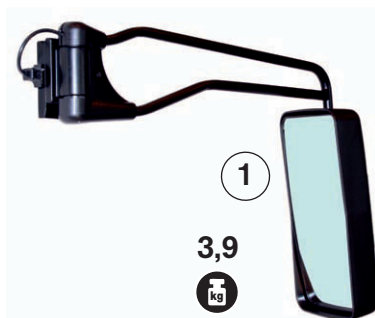

II. E 8 e8 PP Ø 20 mm

Číslo Nr.	Typ / Type	↙ (mm)	Popis / Description
1 2204	Z 750.22402 P / D 1254.20 P	319 x 533 x 718	
2574	D 1254.20 P	169 x 377 x 704	
2029	Z 750.22402 P	213 x 410 x 110	
2661	Z 750	198 x 393 x 29	
2150	Mezikus / Spacer	128 x 48 x 23	
2148	Kabel / Cable	3500	
2 2208	Z 750.424020 P / D 1254.21 P	319 x 533 x 718	
2564	D 1254.21 P	169 x 377 x 704	
2083	Z 750.424020 P	213 x 410 x 110	
2661	Z 750	198 x 393 x 29	
2150	Mezikus / Spacer	128 x 48 x 23	
2148	Kabel / Cable	3500	

IVECO ARWAY CROSSWAY



II. E 8 e8 PP Ø 20 mm

Číslo Nr.	Typ / Type	↙ (mm)	Popis / Description
1 2202	Z 750.22402 P / D 1195.20 L	205 x 228 x 523	
2571	D 1195.20 L	81 x 189 x 354	
2029	Z 750.22402 P	213 x 410 x 110	
2661	Z 750	198 x 393 x 29	
2149	Mezikus / Spacer	128 x 48 x 23	
2147	Kabel / Cable	1500	
2 2203	Z 750.22402 P / D 1195.20 P	630 x 276 x 597	
2572	D 1195.20 P	620 x 155 x 431	
2029	Z 750.22402 P	213 x 410 x 110	
2661	Z 750	198 x 393 x 29	
2150	Mezikus / Spacer	128 x 48 x 23	
2148	Kabel / Cable	3500	

* možno použiť na IVECO Low Entry / is possible to use on IVECO Low Entry

IVECO ARWAY S

II.

E 8

e8

PP

Ø 20 mm

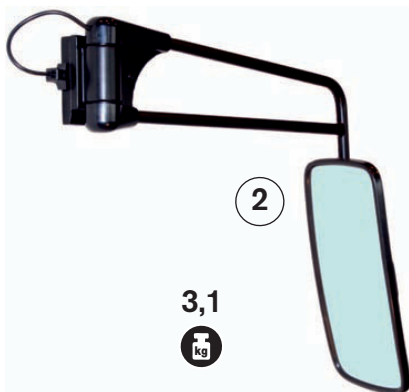

1

Číslo Nr.	Typ / Type	↙ (mm)	Popis / Description
2212	Z 700.024220 / D 1195.22 L	146 x 218 x 524	
2578	D 1195.22 L	81 x 189 x 354	
2071	Z 700.024220	215 x 410 x 85	
2513	Z 700.024	199 x 397	
2149	Mezikus / Spacer	128 x 48 x 23	
2147	Kabel / Cable	1500	



2

2213	Z 700.024220 / D 1195.22 P	633 x 305 x 590	
2579	D 1195.20 P	620 x 155 x 431	
2071	Z 700.024220	215 x 410 x 85	
2513	Z 700.024	199 x 397	
2150	Mezikus / Spacer	128 x 48 x 23	
2148	Kabel / Cable	3500	

TEDOM 11C12

II.

E 8

e8

PP

Ø 20 mm



1

Číslo Nr.	Typ / Type	↙ (mm)	Popis / Description
2243	Z 750.22402 P / D 1279.20 L	204 x 245 x 589	
2591	D 1279.20 L	98 x 226 x 422	
2029	Z 750.22402 P	213 x 410 x 110	
2661	Z 750	198 x 393 x 29	
2149	Mezikus / Spacer	128 x 48 x 23	
2160	Kabel / Cable	1000	



2

2242	Z 750.22402 L / D 1271.20 P	794 x 231 x 596	
2576	D 1271.20 P	754 x 178 x 428	
2030	Z 750.22402 L	213 x 410 x 110	
2661	Z 750	198 x 393 x 29	
2150	Mezikus / Spacer	128 x 48 x 23	
2160	Kabel / Cable	1000	

ŠKODA TRAMVAJ 15T



II. E 8 e8 ABS Ø 20 mm

Číslo Nr.	Typ / Type	↙ (mm)	Popis / Description
1 2310	Z 605.224020 / M 1290.20 L	185 x 248 x 572	
2312	M 1290.20 L	141 x 200 x 450	
2332	Z 605.224020	201 x 386 x 119	
2318	Z 600	181 x 366	
2 2149	Mezikus / Spacer	128 x 48 x 23	
2311	Z 605.224020 / M 1290.20 P	185 x 248 x 572	
2313	M 1290.20 P	141 x 200 x 450	
2332	Z 605.224020	201 x 386 x 119	
2318	Z 600	181 x 366	
2150	Mezikus / Spacer	128 x 48 x 23	

METRO ŠKODA

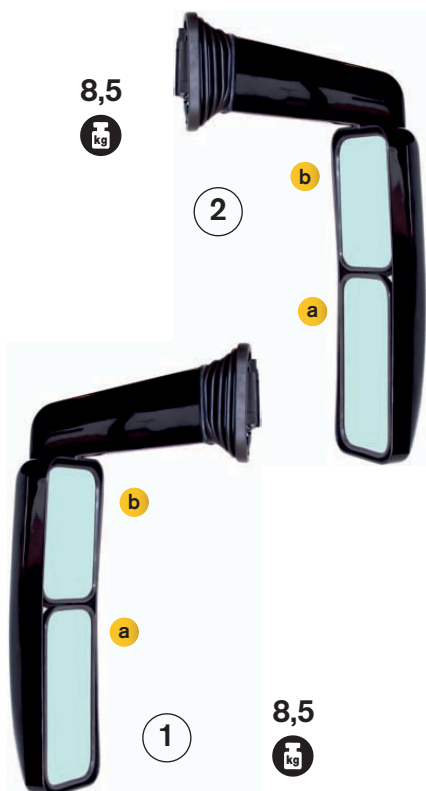

II. N PESL Ø 18 mm

Číslo Nr.	Typ / Type	↙ (mm)	Popis / Description
1 2102	METRO K Z 398 / Z 500 L	350 x 810 x 550	
2137	ZR 500 / M 3	a 345 x 165	
2136	ZR 398 / M 3	b 263 x 165	
2123	Mezikus / Spacer	204 x 114 x 26,5	
2 2103	METRO K Z 398 / Z 500 P	350 x 810 x 550	
2137	ZR 500 / M 3	a 345 x 165	
2136	ZR 398 / M 3	b 263 x 165	
2123	Mezikus / Spacer	204 x 114 x 26,5	

D 1199, D 1203, M 1297

FE

D 1199.1x0



Číslo Nr.	Typ / Type	A (mm)	B (mm)	C (mm)	D (mm)	α (°)	Kg	Popis / Description
2585	D 1199.100	190	251	100	18	-	0,68	
2586	D 1199.110	190	251	-	18	-	0,6	
2568	D 1199.120	190	251	280	18	-	0,96	
2580	D 1203.100	-	88	100	18	60	0,25	
2151	M 1297.100	-	68	100	18	90	0,23	

D 1199.110

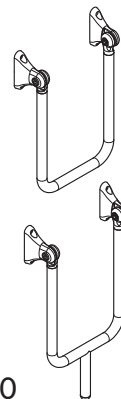
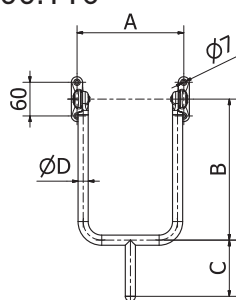

M 1297.100

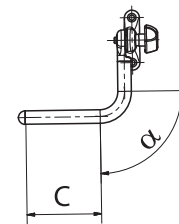

D 1203.100

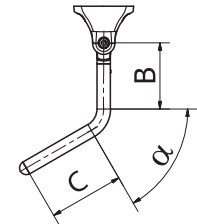

D 1203.100

D 1199.1x0

D 210

FE

D 210.x



Číslo Nr.	Typ / Type	A (mm)	B (mm)	C (mm)	D (mm)	α (°)	Kg	Popis Description
2601	D 210.0	152	155	-	16	132	0,55	
2602	D 210.1	250	125	-	16	110	0,6	
2604	D 210.3	232	100	-	16	34	0,6	
2605	D 210.4	152	125	-	16	72	0,54	
2575	D 210.4-P	152	125	-	16	72	0,54	
2642	D 210.5	152	280	-	16	-	0,65	
2682	D 210.51	152	213	-	18	-	0,84	



D 210.4-P

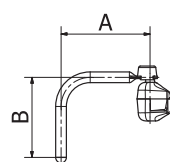

D 210.x

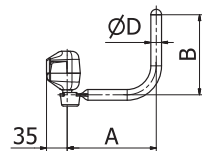

D 210.51

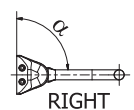
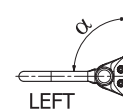
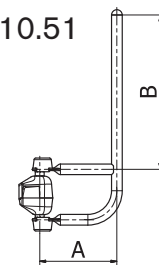
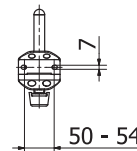

D 32X AVIA, D 980, D 1103

FE



D 320.1



D 325.3



D 980.21 P

Číslo Nr.	Typ / Type	A (mm)	B (mm)	C (mm)	D (mm)	α (°)	Kg	Popis Description
2608	D 320.1	372	min. 396	494	16	90	1,12	
2609	D 320.2	270	min. 396	494	16	90	1,1	
2610	D 320.3	172	min. 396	494	16	90	1,0	
2629	D 325.1	372	min. 396	494	18	90	1,22	
2630	D 325.2	270	min. 396	494	18	90	1,2	
2631	D 325.3	172	min. 396	494	18	90	1,1	
2625	D 980 L	220	490	547	18	135	1,7	
2690	D 980.20 L	220	490	547	18	135	1,7	
2626	D 980 P	420	490	547	18	45	2,1	
2688	D 980.12 P	525	490	547	18	-	1,6	
2687	D 980.20 P	525	490	547	18	45	2,3	
2691	D 980.21 P	525	490	547	18	45	2,3	
2673	D 1103.21 L	min. 440	min. 550	770	18	90	1,7	
2671	D 1103.22 L	min. 300	min. 550	770	18	90	1,57	
2677	D 1103.23 P	min. 440	min. 550	770	18	90	1,8	
2678	D 1103.24 P	min. 300	min. 550	770	18	90	1,68	

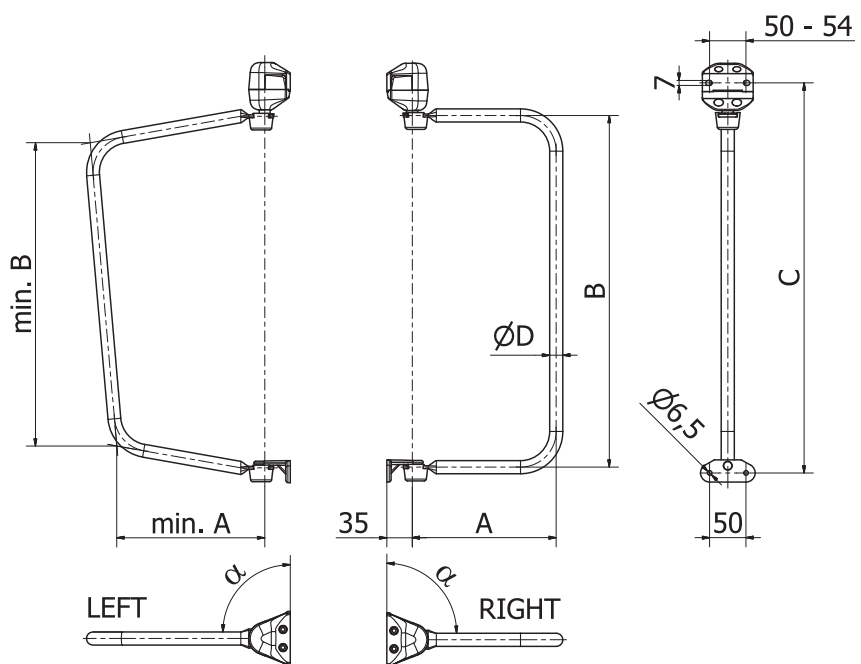

D 220, D 695 – D 696 KAROSA, M 1274

FE

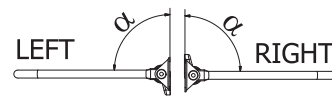
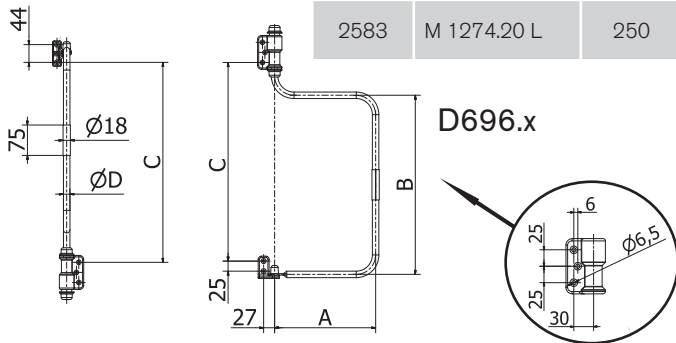

Číslo Nr.	Typ / Type	A (mm)	B (mm)	C (mm)	D (mm)	α (°)	Kg	Popis / Description
2606	D 220.2 L	min.358	min.393	542	16	90	1,1	
2643	D 220.2 P	min.358	min.393	542	16	90	1,1	
2607	D 220.3 L	min.253	min.408	542	16	90	1	
2644	D 220.3 P	min.253	min.408	542	16	90	1	
2620	D 695.11 L	190	517	564	16/18	42	1,03	
2622	D 695.12 L	190	517	564	16/18	42	1,03	
2621	D 696.11 P	250	443	490	16/18	0	1,06	
2623	D 696.12 P	250	443	490	16/18	0	1,06	
2583	M 1274.20 L	250	352	-	16	105	0,9	

D 705, D 1094, D 11XX KAROSA 900

FE

D 705.20 L



Číslo Nr.	Typ / Type	A (mm)	B (mm)	C (mm)	D (mm)	α (°)	Kg	Popis / Description
2657	D 705.20 L	130	146	-	18	120	1,4	
2689	D 705.21 L	130	146	-	18	120	1,4	
2658	D 705.20 P	586	271	-	18	10	2,6	
2680	D 1094.20 L	140/155	151	-	18	0/90	1,56	
2679	D 1094.20 P	100/155	151	-	18	0/90	1,51	
2695	D 1148.21 P	646	300	-	18	5	2,3	
2699	D 1149.20 L	130	251	-	18	90	1,4	
2597	D 1153.20 L	100/75	178	-	18	10/110	1,4	

D 1148.21 P

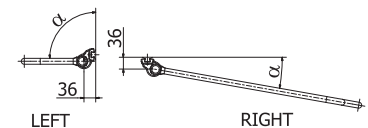
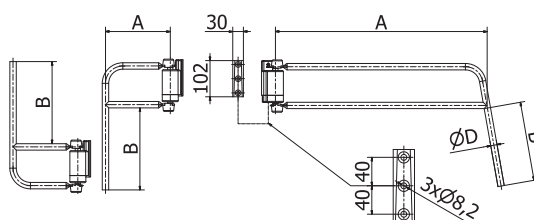

D 970, M 107x, M 129x TATRA

FE

M 1076.100

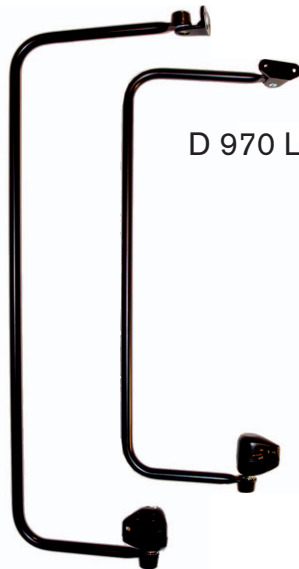

D 970 L

Číslo Nr.	Typ / Type	A (mm)	B (mm)	C (mm)	D (mm)	α (°)	Kg	Popis Description
2624	D 970 L	249	683	642	18	60	1,3	
2686	D 970 P	249	683	642	18	90	1,3	
2656	M 1076.100	189	426	385	18	-	0,97	
2655	M 1077.100	220	816	775	18	-	1,4	
-	M 1293.100	198	484	445	18	-	1,1	
2552	M 1295.100	260	959	920	18	-	1,6	

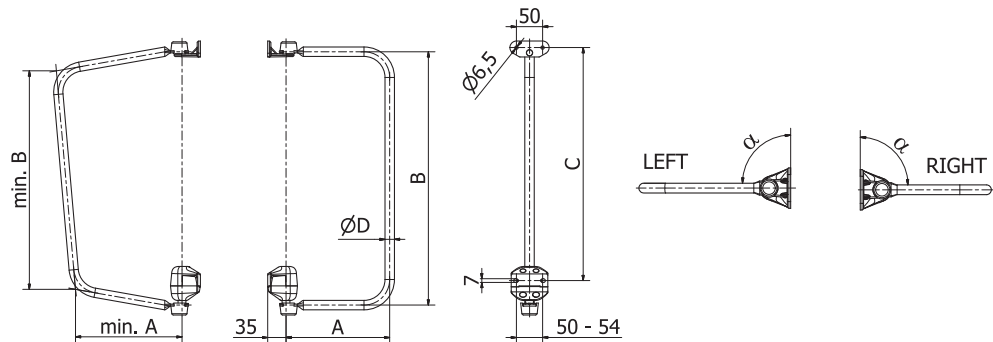

D 1082 ZETOR

FE

D 1082.10 P



Číslo Nr.	Typ / Type	A min (mm)	A max (mm)	B (mm)	D (mm)	α (°)	Kg	Popis / Description
2667	D 1082.10 L	400	590	172	16	70	0,95	
2668	D 1082.10 P	400	590	172	16	70	0,95	
2684	D 1082.20 L	400	590	172	16	70	1	
2685	D 1082.20 P	400	590	172	16	70	1	

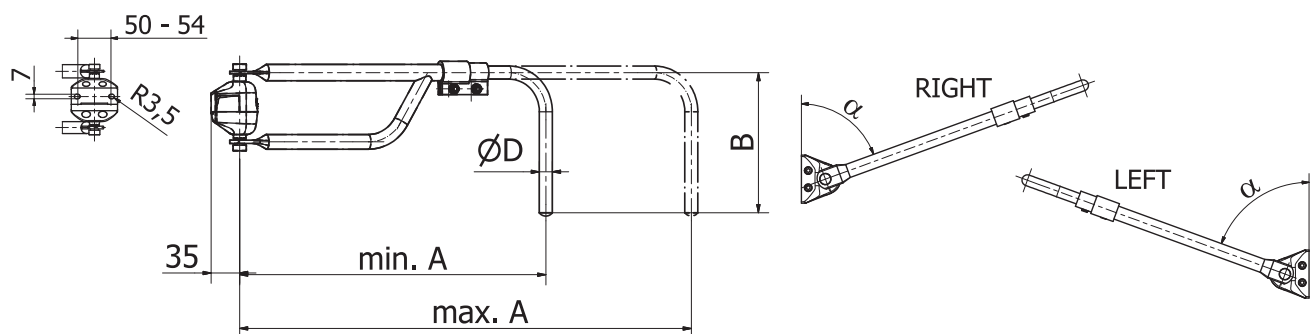

D 1195, D 123x, D 125x, D 127x BUS

FE +ABS

D 1195.20 L

D 1271.20 P

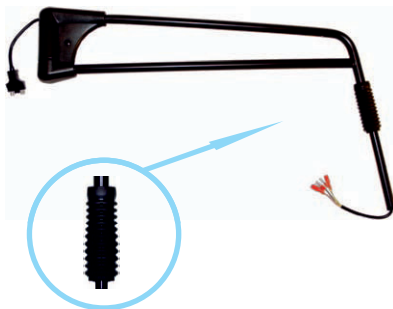
D 1239.20 P

Číslo Nr.	Typ / Type	A (mm)	B (mm)	C (mm)	D (mm)	α (°)	Kg	Popis / Description
2571	D 1195.20 L	135	215	-	20	110	1,25	
2566	D 1195.21 L	135	215	-	20	110	1,25	
2578	D 1195.22 L	135	215	-	20	110	1,26	
2572	D 1195.20 P	560	285	-	20	10	1,78	
2565	D 1195.21 P	560	285	-	20	10	1,78	
2579	D 1195.22 P	560	285	-	20	10	1,79	
2589	D 1238.20 L	185	269	-	20	80	1,55	
-	D 1238.20 P	546	339	-	20	10	2,1	
2590	D 1239.20 P	664	293	-	20	10	2,1	
2574	D 1254.20 P	643	283	-	20	10	1,95	
2564	D 1254.21 P	643	283	-	20	10	1,94	
2577	D 1271.20 L	185	277	-	20	80	1,24	
2576	D 1271.20 P	657	289	-	20	10	1,94	
2562	D 1272.20 L	233	299	-	20	110	1,4	
2563	D 1272.20 P	535	259	-	20	15	1,79	
2567	D 1275.20 L	185	272	-	20	80	1,24	
2591	D 1279.20 L	185	272	-	20	110	1,24	

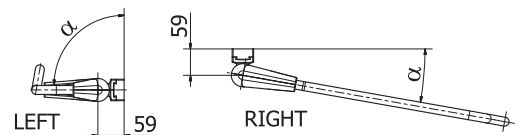
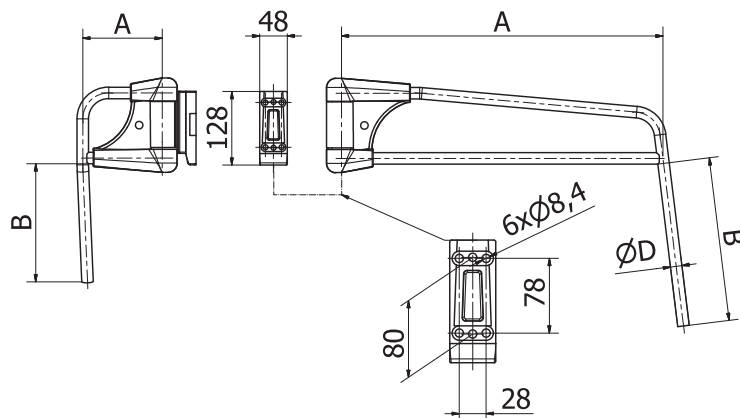

D 1142, M 1268, M 1277 TATRA

FE

M 1268.200

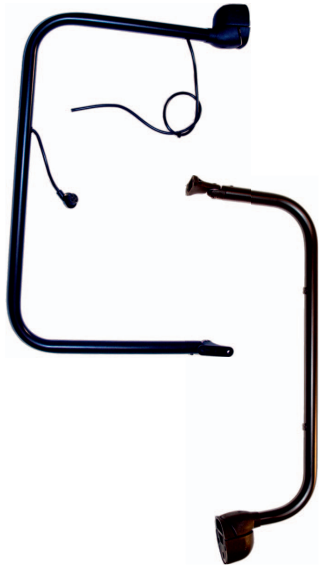

D 1142.31 P

Číslo Nr.	Typ / Type	A (mm)	B (mm)	C (mm)	D (mm)	α (°)	Kg	Popis Description
2599	D 1142.31P	222	678	737	28	90	1,6	
2598	D 1142.300	222	678	737	28	90	1,6	
2569	M 1268.100	420	705	738	28	90	2,25	
2588	M 1268.200	420	705	738	28	90	2,5	
-	M 1277.100	420	900	933	28	90	2,8	

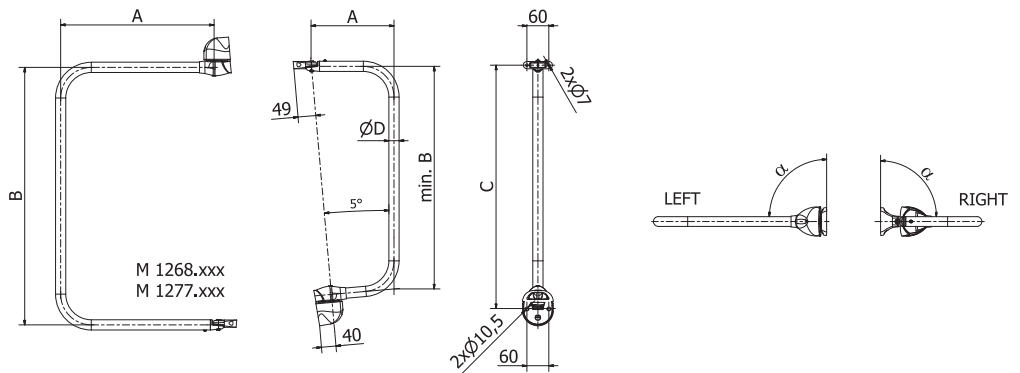

D 128x, D 129x BUS

FE +ABS



D 1286.20 L







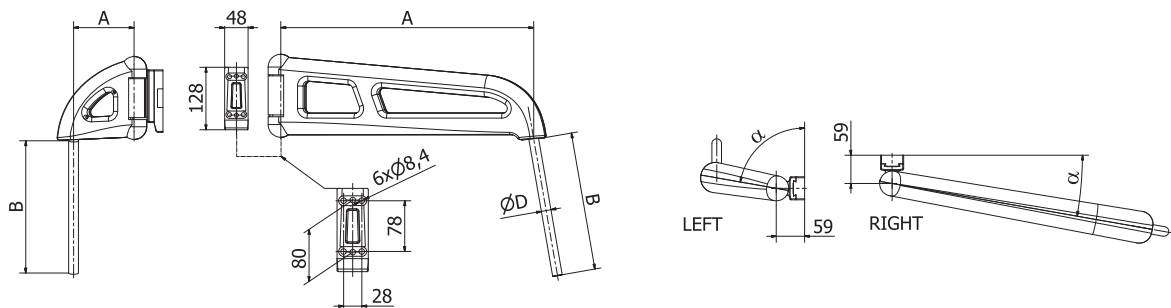

































































D 1288.20 P

Číslo Nr.	Typ / Type	A (mm)	B (mm)	C (mm)	D (mm)	α (°)	Kg	Popis Description
2322	D 1286.20 L	126	280	-	20	80	1,25	
2323	D 1288.20 P	520	400	-	20	10	2,65	
-	D 1288.23 P	520	400	-	20	10	2,65	
2312	D 1290.20 L	126	280	-	20	32	1,25	
2313	D 1290.20 P	126	280	-	20	32	1,25	
-	D 1294.20 L	126	280	-	20	122	1,25	



NÁHRADNÍ SKLA / SPARE GLASSES

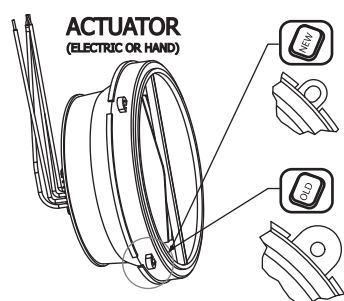

Číslo Nr.	Typ / Type	↙ (mm)	Popis / Description
2522	SKLO BW	180 x 380	 
2534	SKLO BW	180 x 380	 
2523	SKLO MC	174 x 364	 
2535	SKLO MC	174 x 364	 
2502	Z 200	135 x 207	 
2480	Z 200 N	135 x 207	 
2501	Z 201.100030	135 x 207	 
2481	Z 201 N	135 x 207	 
2489	Z 320	193 x 179	 
2490	Z 320	193 x 179	   
2518	Z 350	161 x 246	 
2482	Z 350 N	161 x 246	 
2519	Z 350.012,112	161 x 246	   
2524	Z 350.024,124	161 x 246	   
2504	Z 358	170 x 245	 
2483	Z 358 N	170 x 245	 
2506	Z 360	170 x 245	 
2484	Z 360 N	170 x 245	 
2525	Z 398	160 x 260	 
2485	Z 398 N	160 x 260	 
2536	Z 398.012	160 x 260	   
2507	Z 400.1	175 x 270	 
2508	Z 400.2	175 x 270	   
2486	Z 400 N	175 x 270	 
2509	Z 430.1	170 x 335	 
2487	Z 430 N	170 x 335	 
2510	Z 430.012	170 x 335	   
2511	Z 430.024	170 x 335	   

NÁHRADNÍ SKLA / SPARE GLASSES

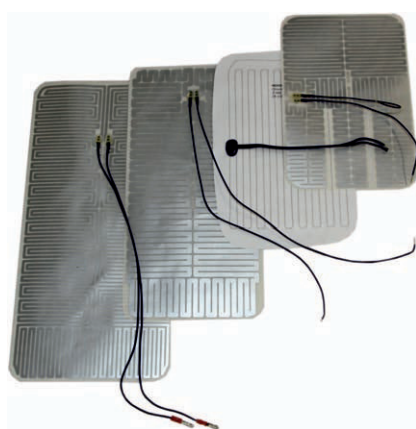

Číslo Nr.	Typ / Type	↙ (mm)	Popis / Description
2491	Z 620	205 x 361	
2540	Z 620 NEW	198 x 355 x 30	
2493	Z 620 OLD	198 x 355 x 30	
2492	Z 620	205 x 361	
2537	Z 630.100010	Ø 300	
2538	Z 630.100020	Ø 300	
2512	Z 700.1	199 x 397	
2488	Z 700 N	199 x 397	
2513	Z 700.024	199 x 397	
2533	Z 750 N	191 x 386	
2494	Z 800	217 x 447	
2539	Z 800 NEW	208 x 442 x 30	
2496	Z 800 OLD	208 x 442 x 30	
2495	Z 800	217 x 447	

TOPNÉ VLOŽKY / HEATING FOILS



Číslo Nr.	Typ / Type	↙ (mm)	Popis / Description
2530	Z 320	184 x 172	
2520	Z 350.112	158 x 246	
2521	Z 350.124	158 x 246	
2514	Z 400	158 x 246	
2515	Z 430.012	160 x 330	
2517	Z 430.024	160 x 330	
2531	Z 620	170 x 335	
2516	Z 700	180 x 380	
2526	Z 750	180 x 380	
2532	Z 800	180 x 380	

LOŽISKA DRŽÁKŮ / BEARINGS OF HOLDERS



Číslo Nr.	Typ / Type	↙ (mm)	Popis / Description
1 2646	Ložisko držáku D 1044 L Bearing of holder D 1044 L	115 x 60 x 50	
1 2645	Ložisko držáku D 1044 P Bearing of holder D 1044 P	115 x 60 x 50	
2 2628	Ložisko držáku typ 811.1 Bearing of holder type 811.1	80 x 70 x 55	
3 2742	Ložisko držáku typ 811.2 Bearing of holder type 811.2	80 x 70 x 55	
4 2747	Krytka držáku D 811.2 Cover of holder D 811.2	Ø 30 x 21	
5 2154	Dvoudílná krytka držáku D 1195 Two-piece cover of holder D 1195	160 x 140 x 55	
-	Ložisko držáku D 1195 L/P Bearing of holder D 1195 L/P	115 x 60 x 50	

KABELY / CABLES

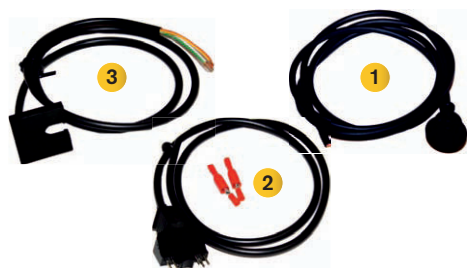

Číslo Nr.	Typ / Type	↙ (mm)	Popis / Description
1 2528	Kabel D 1142 Tatra Cable D 1142 Tatra	1500	
2 2664	Kabel do držáku Cable to holder	1360	
3 2660	Kabel do karoserie Cable to bus body	4500	

LOŽISKA DRŽÁKŮ / BEARINGS OF HOLDERS



Číslo Nr.	Typ / Type	↙ (mm)	Popis / Description
1 2149	Mezikus levý Mounting wedge left	128 x 48 x 23	
1 2150	Mezikus pravý Mounting wedge right	128 x 48 x 23	
2 2651	Ovladač Controler	40 x 40 x 55	
3 2328	Ruční kloub Hand actuator	Ø 133 x 52	
4 2681	Motor Eletric actuator	Ø 133 x 52	24 V DC
5 2745	Zadní krytka Z 750 Back cover Z 750	142 x 150 x 30	
6 2746	Vnější plast Z 750 External plastic Z 750	213 x 410 x 80	
7 2144	Pryžová manžeta Rubber cuff	200 x 120 x 55	
8 2151	Závitová podložka Thread raising-piece	120 x 18 x 18	
9 2157	Konektor kabelu Connector Cable	Ø 5 x 30	
2158			

VYSVĚTLIVKY / ERKLÄRUNGEN / SEGNI / LEGEND

	Kompletní zrcátko Komplettspiegel	Specchio completo Complete mirror		Kabel držáku (počet žil) Trägerskabel (Aderanzahl)	Cavo del braccio (numero dei fili) Holder's cable (numbers of cores)
	Držák Spiegelhalter	Braccio Holder		Kabel do karoserie (počet žil) Kabel in Karosserie (Aderanzahl)	Cavo per carrozzeria (numero dei fili) Cable for vehicle (numbers of cores)
	Držák Spiegelhalter	Braccio Holder		Hmotnost (kg) Gewicht (kg)	Peso (kg) Weight (kg)
	Použitelné pro obě strany Links / rechts einsetzbar	Per applicazione a sinistra / destra Applicable for left / right side	ABS	Plast ABS Plastik ABS	Plastico ABS Plastic ABS
	Použitelné pro pravou stranu Rechts einsetzbar	Per applicazione a destra Applicable for right side	PP	Plast PP Plastik PP	Plastico PP Plastic PP
	Použitelné pro levou stranu Links einsetzbar	Per applicazione a sinistra Applicable for left side	PESL	Skelný laminát Glasschichtstoff	Plastico a vetro Glass fibre
	Sklo ploché Flachglas	Vetro piano Flat glass	FEP	Ocelový plech povrchově upravený Stahlblech oberflächenberichtigt	Lamiera d' acciaio con trattamento superficiale Steel plate with surface finishing
	Sklo sférické - poloměr (mm) Sphärisches Glas - Radius (mm)	Vetro sferico - raggio (mm) Spherical glass - radius (mm)	FE	Ocelová trubka Stahlrohr	Tubo in acciaio Steel tube
	Vyhřívání - napětí (V) Beheizung - Spannung (V)	Riscaldamento - tensione (V) Heating - voltage (V)	E8	Homologace dle EHK č.46 Homologation nach ECE Nr.46	Omologazione a norma ECE Nr.46 Homologation according to ECE Nr.46
	Vyhřívání - příkon (W) Beheizung - Leistungsaufnahme (W)	Riscaldamento - potenza (W) Heating - power consumption (W)	e8	Homologace dle 2003/97/ES Homologation nach 2003/97/EC	Omologazione a norma 2003/97/EC Homologation according to 2003/97/EC
	Topná vložka Heizfolie	Foglio termico Heating foil	N	Nehomologováno Unhomologiert	Senza omologazione No homologation
	Sklo s topnou vložkou Glas mit Heizfolie	Vetro con foglio termico Glass with heating foil	(2M)	Zrcátko (pod 2 metry) Spiegel (unter 2 meter)	Specchio (sotto 2 m) Mirror (under 2 m)
	Pro vnitřní použití Für Innenbenutzung	Solo per applicazione interna Only for indoor use		Vnější plast Innerplast	Plastico esterno External plastic
	Mezikus Zurischenstrück	Supporto a cuneo Mounting wedge		Šrouby Imbus Schraube Imbus	Viti Imbus Screws Imbus
	Elektrické ovládání elektrische Bedienung	Regolazione elettrica Electric control		Napájení 12 V, DC Versorgung 12 V, DC	Alimentazione 12 V, DC Current supply 12 V, DC
	Ruční ovládání Manuelle Bedienung	Regolazione manuale Manual control		Napájení 24 V, DC Versorgung 24 V, DC	Alimentazione 24 V, DC Current supply 24 V, DC
	Sklo podlepené Unterkebleglas	Vetro sotto-incollato Under-sticked glass		Ruční kloub Handgelenk	Attuatore manuale Hand actuator
	Sklo nepodlepené Glas ohne Unterkleben	Vetro non sotto-incollato Non under-sticked glass		Motor Getriebe	Attuatore Electric actuator
	Sklo s nosičem "NEW" Glas mit Träger "NEW"	Vetro con supporto "NEW" Glass with porter "NEW"		Zadní krytka Hintere Abdeckung	Calotta posteriore Back cover
	Sklo s nosičem "OLD" Glas mit Träger "OLD"	Vetro con supporto "OLD" Glass with porter "OLD"		Kloub držáku Haltergelenk	Snodo del braccio Holder's joint
	Sklo s nosičem Glas mit Träger	Vetro con supporto Glass with porter		Rámeček zrcátka Spiegelrahmen	Cornicetta dello specchio Mirror's frame

Nejčastější použití
Häufig benutzte
Usi comuni
Common uses

Trída zrcátka
Spiegelklasse
Classe dello specchio
Mirror class

Homologace
Homologation
Omologazione
Homologation

Materiál výrobku
Material des Produkt
Materiale della prodotto
Material of the product

Z 750 BUS II. E8 e8 PP Ø 18 – 20 mm

Název výrobku
Markierung
Titolo dello prodotto
Title of product

1,9

Průměr držáku
Durchmesser der Spiegelstange
Diametro del braccio
Diameter of the mirror holder

Číslo Nr.	Typ / Type	↙ (mm)	Popis / Description
2030	Z 750.22402 L	213 x 410 x 110	
2029	Z 750.22402 P	213 x 410 x 110	
2661	Z 750	196 x 393 x 29	
2526	Z 750	180 x 380	
2745	Z 750	142 x 150 x 30	
2681	Z 750	Ø 133 x 52	
2746	Z 750	213 x 410 x 80	

Hmotnost
Gewicht
Peso
Weight

Číslo výrobku
Produktnummer
Numero del prodotto
Number of product

Typ výrobku
Spiegeltyp
Tipo dello specchio
Mirror type

Rozměry
Abmessungen
Dimensioni
Dimensions

Z 750.22402 P

Z – zrcátko / spiegel / specchio / mirror
M – držák (kolejová vozidla) / Halter (Fahrzeuge)
 braccio (materiale rotabile) / Holder (rolling stock)
D – držák (silniční vozidla) / Halter (Straßenfahrzeuge)
 braccio (veicoli stradali) / Holder (road vehicles)

